

ENGLISH



Canon
PowerShot A710 IS
DIGITAL CAMERA

Canon



The Components Guide

Preparation

Shooting

Playback/Erasing

Menus and Settings

Printing

Downloading Images
to a Computer

Basic

Camera User Guide

Please Read This First

This guide explains how to prepare the camera and use its basic features.

Flowchart and Reference Guides

The following guides are available. Refer to them as necessary according to the flowchart below.

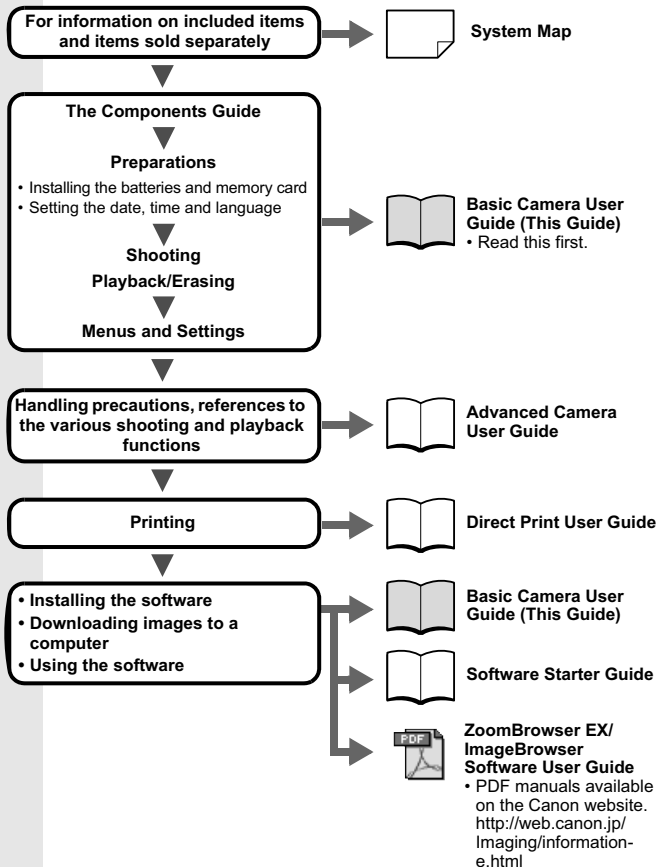

In this guide, the *Basic Camera User Guide* is called the *Basic Guide*, and the *Advanced Camera User Guide* is called the *Advanced Guide*.

The Components Guide

■ Front View

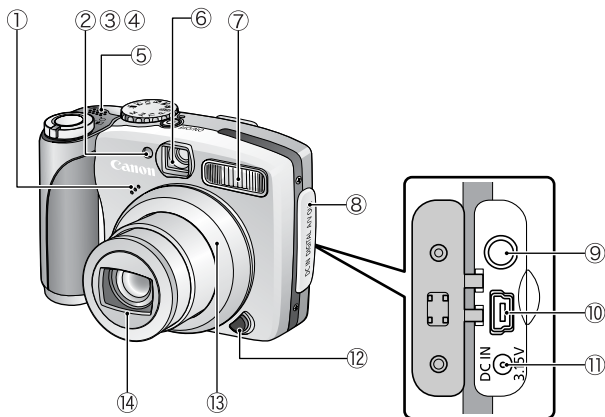

- ① Microphone (*Advanced Guide* p. 79)
- ② AF-assist Beam (*Advanced Guide* p. 20)
- ③ Red-Eye Reduction Lamp (p. 12)
- ④ Self-Timer Lamp (p. 16)
- ⑤ Speaker
- ⑥ Viewfinder Window (*Advanced Guide* p. 16)
- ⑦ Flash (p. 12)
- ⑧ Terminal Cover
- ⑨ A/V OUT (Audio/Video output) Terminal (*Advanced Guide* p. 88)
- ⑩ DIGITAL Terminal (p. 27)
- ⑪ DC IN Terminal (Power input) (*Advanced Guide* p. 109)
- ⑫ Ring Release Button (*Advanced Guide* p. 112)
- ⑬ Ring (*Advanced Guide* p. 112)
- ⑭ Lens

■ Back View

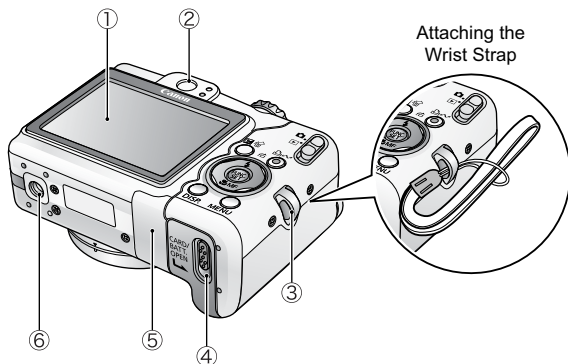

- ① LCD Monitor (*Advanced Guide* p. 12)
- ② Viewfinder (*Advanced Guide* p. 16)
- ③ Wrist Strap Mount
- ④ Memory Card Slot / Battery Cover Lock (p. 5)
- ⑤ Memory Card Slot / Battery Cover (p. 5)
- ⑥ Tripod Socket



The LCD monitor is covered with a thin plastic film for protection against scratches during shipment. Remove it before using the camera.

■ Controls

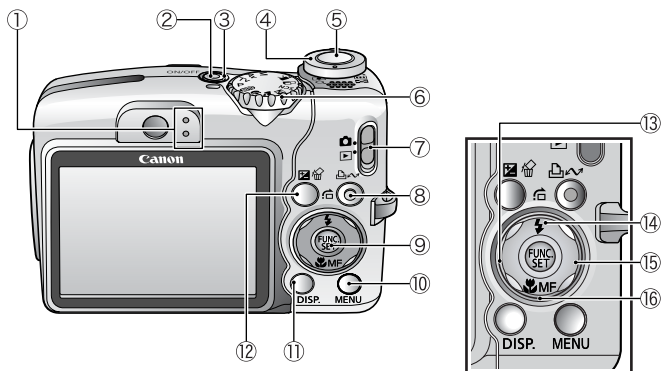

- ① Indicators (p. 4)
- ② Power Lamp
- ③ Power Button (p. 8)
- ④ Zoom Lever (p. 12, *Advanced Guide* p. 70)
Shooting: (Wide Angle)/ (Telephoto)
Playback: (Index)/ (Magnify)
- ⑤ Shutter Button (p. 8)
- ⑥ Shooting Mode Dial (pp. 8, 9)
- ⑦ Mode Switch (pp. 8, 18)
- ⑧ (Print/Share) Button (pp. 22, 30)
- ⑨ **FUNC./SET** (Function/Set) Button (*Advanced Guide* p. 18)
- ⑩ **MENU** Button (*Advanced Guide* p. 19)
- ⑪ **DISP.** (Display) Button (*Advanced Guide* p. 12)
- ⑫ (Exposure)/ (Single Image Erase) Button
(p. 19, *Advanced Guide* p. 51)
- ⑬ Button
- ⑭ (Flash)/ (Jump)/ Button (p. 12, *Advanced Guide* p. 72)
- ⑮ Button
- ⑯ (Macro)/ **MF** (Manual Focus)/ Button
(p. 15, *Advanced Guide* p. 47)

Indicators

The camera indicators will light or blink under the following conditions.



Never do the following while the indicator blinks green. These actions may corrupt image data.

- Shake or jolt the camera
- Shut off the power, or open the memory card slot/battery cover

- **Upper Indicator**

Green: Ready to shoot

Blinking Green: Image recording/reading/erasing/transferring (when connected to a computer)

Orange: Ready to shoot (flash on)

Blinking Orange: Ready to shoot (camera shake warning), charging flash

- **Lower Indicator**

Yellow: Macro mode/Manual focus mode/AF lock mode

Blinking Yellow: Focusing difficulty (camera beeps once)

Preparations

1. Installing the batteries.

1. Slide the memory card slot/battery cover lock in the direction of the arrow and open the cover.
2. Insert the 2 supplied AA-size alkaline batteries, or separately sold AA-size NiMH batteries.

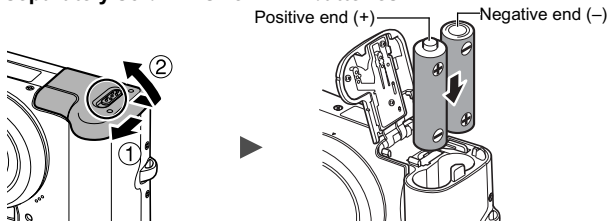

➔ See the *Advanced Guide: Battery Handling* (p. 103).

2. Inserting the Memory Card.

1. Insert the memory card until it clicks into place.

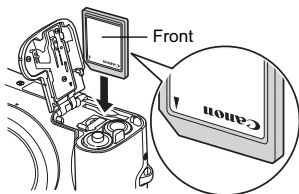

2. Close the memory card slot/battery cover.



Ensure that the memory card is correctly oriented before inserting it in the camera. It may damage the camera, or the camera may not recognize the card, if it is inserted incorrectly.

➔ See the *Advanced Guide: Handling the Memory Card* (p. 105).

➔ See the *Advanced Guide: Formatting Memory Cards* (p. 26).

■ To Remove the Memory Card

Push the memory card with your finger until the memory card clicks and then release it.

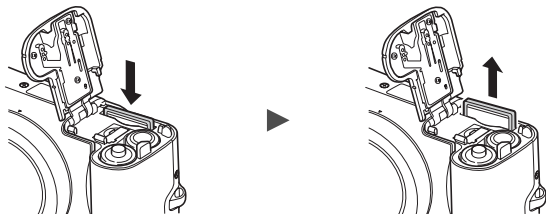

You can use SD memory cards, SDHC memory cards and MultiMediaCards with this camera. These cards are collectively called memory cards in this guide.



First Time Settings

■ Setting the Date/Time

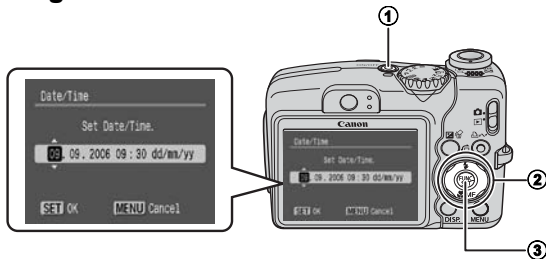

1. Press the power button (①).
2. Use the **←** or **→** button to select an item and the **↑** or **↓** button to change its value (②).
3. Confirm that the correct time is displayed and press the **FUNC./SET** button (③).

The date and time can also be set in the Set up menu (p. 21).



The date/time setting screen will appear when the camera power is turned on for the first time, or when the capacity of the lithium date/time battery is depleted.

➡ See the *Advanced Guide: Replacing the Date Battery* (p. 116).

■ Setting the Display Language

1. Set the mode switch to **▶** (playback).
2. Hold down the **FUNC./SET** button and press the **MENU** button.
3. Use the **↑**, **↓**, **←** or **→** button to select a language and press the **FUNC./SET** button.

The display language can also be set in the Set up menu (p. 21).

Shooting

1. Press the power button.

The start-up sound will play and the start-up image will display in the LCD monitor.

- Pressing the power button again turns the power off.
- Pressing the power button while pressing and holding the DISP. button will turn on the mute setting which will mute all sounds except for warning sounds.

Power button

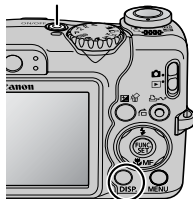

DISP. button

➔ See the *Advanced Guide: Using the LCD Monitor* (p. 12).

➔ See the *Advanced Guide: Power Saving Function* (p. 17).

➔ See the *Advanced Guide: Set up Menu* (p. 22).

➔ See the *Advanced Guide: My Camera Menu* (p. 24).

2. Set the mode switch to (shooting)

(①).

3. Set the shooting mode dial to **AUTO**

(②).

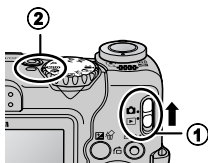

4. Aim the camera at the subject.

5. Focus and shoot.

1. Press the shutter button halfway to focus.

When the camera focuses, the camera beeps twice and the indicator lights green (orange when using the flash). Also, the AF frame appears in green on the LCD monitor at the point where the camera is focused.

Indicators

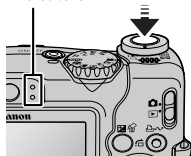

2. Press the shutter button fully to shoot.

The shutter sound will play and the image will record. The indicator will blink green while the image is recorded to the memory card.

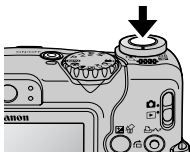

- ➔ See *Indicators* (p. 4).
- ➔ See the *Advanced Guide: Selecting an AF Frame* (p. 44).
- ➔ See the *Advanced Guide: Setting the Image Stabilizer Function* (p. 28).
- ➔ See the *Advanced Guide* for the various shooting methods available.

■ Reviewing an Image Right After Shooting

After a shot is taken, the image appears in the LCD monitor for approximately 2 seconds.

You can continue to display images regardless of the review duration setting with the following procedures.

- Keeping the shutter button pressed after a shot.
- Pressing the **FUNC./SET** or **DISP.** button while the image is displayed in the LCD monitor.

To stop displaying the image, press the shutter button halfway.

- ➔ See the *Advanced Guide: Review* (p. 20).
- ➔ See *Erasing* (p. 19).







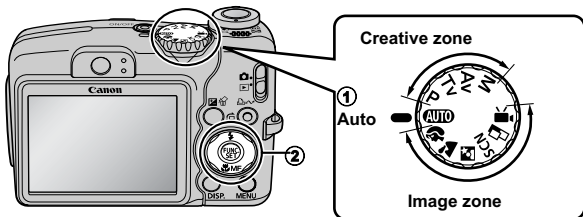















Selecting a Shooting Mode

1. Set the shooting mode dial to the desired mode (①).

In the **SCN** and **P** modes, use the **←** or **→** button (②) to select a shooting mode.



■ Shooting Modes

Image zone	Auto  The camera automatically selects settings.
	When a shooting mode appropriate for the shooting conditions is selected, the camera automatically adjusts settings for optimal shooting.
	Portrait  Blurs the background and makes a person stand out. 
	Landscape  Optimized for shooting landscape scenes which contain both near and far subjects. 
	Night Scene  Allows you to capture human subjects against the backdrop of an evening sky or night scene. The flash is directed at the person and the shutter speed is slow, so both the person and the background can be beautifully shot. 
	SCN (Special Scene) You can shoot with the most appropriate settings for the scene.
	Night Snapshot  Allows you to take snapshots of people against twilight or night backgrounds by reducing the effects of camera shake even without using a tripod. 
	Kids&Pets  Allows you to capture subjects that move around, such as children and pets, without missing photo opportunities. 
	Indoor  Prevents camera shake and maintains the subject's true color when shooting under fluorescent or tungsten lighting. 
	Foliage  Shoots trees and leaves - such as new growth, autumn leaves or blossoms - in vivid colors. 
Snow  Shoots without a blue tinge and without making people appear dark against a snowy background. 	
Beach  Shoots without making people appear dark near water or sand where reflected sunlight is strong. 	
Fireworks  Captures fireworks in the sky sharply and at optimal exposure. 	
Underwater  Appropriate for shooting images with Waterproof Case WP-DC6 (sold separately). This mode uses an optimal white balance setting to reduce bluish tones and record images with a natural hue. 	

 **Color Accent**

Use this option to have only the color specified in the LCD monitor remain and to transform all others to black and white.



➔ See the *Advanced Guide* (p. 57).

 **Color Swap**

Use this option to transform a color specified in the LCD monitor into another.



➔ See the *Advanced Guide* (p. 59).



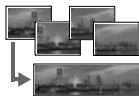

 **Stitch Assist**

Allows you to shoot overlapping images that can later be merged (stitched) to create one panoramic image on a computer.

➔ See the *Advanced Guide* (p. 39).

 **Movie**

Shoots a movie when you press the shutter button.

Apart from [ Standard] mode, you can also select from [ Fast Frame Rate] which is suitable for shooting sports or fast motion, [ Compact] which is convenient for email attachments, [ Color Accent] which has only the color specified in the LCD monitor remain and transforms all others to black and white, and [ Color Swap] which transforms a color specified in the LCD monitor into another color.









➔ See the *Advanced Guide* (p. 35).

P, Tv, Av, M

You can freely select camera settings such as the exposure and aperture value to suit your shooting purposes.

➔ See the *Advanced Guide* (pp. 40 – 43).



- The shutter speed is slow in  or  mode. Always use a tripod to avoid camera shake.
- In , , , ,  or  mode, the ISO speed may increase and cause noise in the image depending on the scene being shot.
- In  mode, shoot with the subject more than 1 m (3.3 ft.) away from the front of the lens.



- To shoot underwater, install the camera in Waterproof Case WP-DC6 (sold separately).
- We recommend you use Waterproof Case WP-DC6 for shooting at ski resorts or beaches.

Using the Zoom

1. Press the zoom lever toward  or .

The zoom can be adjusted from 35 mm – 210 mm (focal length) in 35mm film equivalent terms. The zoom bar appears when you press the zoom lever.

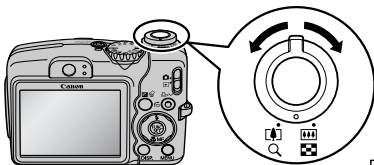



 **Telephoto:** Zooms in on the subject.

 **Wide Angle:** Zooms out from the subject.

Using the Flash

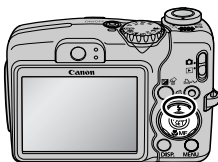
1. Press the  button to cycle through flash settings.







Each time you press the  button, the flash settings will change.

With the red-eye reduction function on:



With the red-eye reduction function off:





	Auto with red-eye reduction	The flash fires automatically and fires the red-eye reduction lamp each time.
	Auto	The flash fires automatically.
	Flash on with red-eye reduction	The red-eye reduction lamp and flash always fire.
	Flash on	The flash always fires.
	Flash off	The flash will not fire.

Red-eye reduction: This feature reduces the effect of light reflecting back from the eyes and making them appear red.

→ See *Setting the Red-Eye Reduction Function* (p. 14).

→ See *Setting the Slow Synchro Function* (p. 14).

 or  cannot be set in **AUTO** mode.

→ See the *Advanced Guide: Functions Available in Each Shooting Mode* (p. 136).

→ See *Selecting a Shooting Mode* (p. 9).



You are recommended to shoot with the camera attached to a tripod or other device if the camera shake warning icon  appears.



When the LCD monitor is on and flash recharging begins, the indicator blinks orange and the LCD monitor turns off. When recharging ends, the indicator turns off and the LCD monitor turns on. The time required for flash recharging will change depending on usage conditions and remaining battery power.

■ Setting the Red-Eye Reduction Function

You can set whether the camera automatically performs red-eye reduction when the flash fires.

1.  (Rec.) Menu ► [Red-Eye] ► [On]*/[Off].

➔ See *Menus and Settings* (p. 20).

* Default setting.

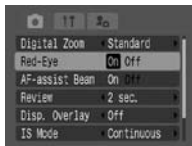

■ Setting the Slow Synchro Function

The flash timing is adjusted to slow shutter speeds. This reduces the chance that only the background will appear dark when a person is shot against a twilight background or night scene, or when an interior shot is taken.

1.  (Rec.) Menu ► [Slow Synchro] ► [On]/[Off]*.

➔ See *Menus and Settings* (p. 20).

* Default setting.

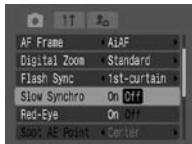

Slow Synchro cannot be set in **AUTO** mode.



When [Slow Synchro] is set to [On], camera shake may become a factor. Use of a tripod is recommended.

Shooting Close-ups (Macro)

1. Press the button.

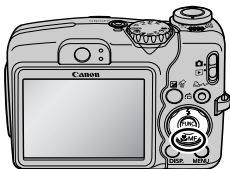



Zoom bar Yellow bar



Macro mode icon

When using the zoom in macro mode, a yellow bar appears below the zoom bar to indicate the range in which you cannot use macro mode to shoot the subject.

If the zoom bar enters the yellow bar range, the macro mode icon  will turn gray. You can still shoot the image, however, the shot will be taken as if in standard shooting mode. The zoom bar disappears after approx. 2 sec.

To cancel the macro mode, press the  button to turn off the  or **MF** display.

	Macro	Use this mode to shoot close-ups of flowers or small items. Image Area at Minimum Shooting Distance from End of Lens to Subject • Maximum wide angle setting: 24 x 18 mm (0.94 x 0.71 in.) Minimum shooting distance: 1 cm (0.39 in.)
--	--------------	--



- Use the LCD monitor to compose close-ups in macro mode since images composed with the viewfinder may be off-center.
- Check the range of the flash when using it in macro mode (*Advanced Guide* p. 120).

This setting cannot be set in some shooting modes.

- ➔ See the *Advanced Guide: Functions Available in Each Shooting Mode* (p. 136).
- ➔ See *Selecting a Shooting Mode* (p. 9).

Using the Self-Timer

1. FUNC. Menu ► * (Drive Mode) ► / / .

► See *Menus and Settings* (p. 20).



* Default setting.

- When the shutter button is pressed fully, the self-timer lamp will blink. When using red-eye reduction, the self-timer lamp will blink and then stay lit for the last 2 seconds.

To cancel the self-timer, follow step 1 and select .



10 sec. Self-Timer: Shoots 10 sec. after you press the shutter button.
• 2 sec. before the shutter releases, the self-timer sound and lamp will speed up*¹.



2 sec. Self-Timer: Shoots 2 sec. after you press the shutter button.
• The self-timer sound beeps quickly*¹ when you press the shutter button and the shutter releases 2 sec. later.



Custom Timer: You can change the delay time (0–10*², 15, 20, 30 sec.) and number of shots (1–10*³).
• When [Delay] is set to 2 or more sec., the self-timer sound begins to beep 2 sec. before the shutter releases. When [Shots] is set higher than 1, the self-timer sound only beeps before the first shot.

* 1 May differ depending on My Camera settings.

* 2 Default setting.

* 3 Default setting is 3 shots.

This setting cannot be set in some shooting modes.

► See the *Advanced Guide: Functions Available in Each Shooting Mode* (p. 136).

► See *Selecting a Shooting Mode* (p. 9).





■ Changing the Delay Time and Number of Shots (🕒)

1. FUNC. Menu ▶  (Drive Mode) ▶  (Custom Timer).

 See *Menus and Settings* (p. 20).



2. Press the MENU button.

3. Select [Delay] or [Shots] using the  or  button and change the settings using the  or  button.



If the [Shots] option is set to 2 or more shots, the following occurs.

- The exposure and white balance are locked at the settings selected for the first shot.
- If the flash is used, the interval between shots lengthens because the flash must charge.
- The interval between shots may lengthen when the built-in memory of the camera fills.
- Shooting will automatically cease if the memory card becomes full.



Playback

1. Set the mode switch to (playback)(①).

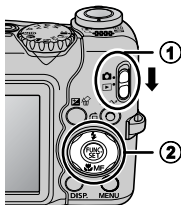
The last image that was played back appears (Resume Playback). If additional images were shot after viewing images in playback mode, the last image that was shot will appear instead. If the memory card has been switched, or the images on the memory card have been edited with a computer, the newest image on the memory card appears.



2. Use the or button to display the image you wish to view (②).

Use the  button to move to the previous image and the  button to move the next image.

Holding the button down advances the images more rapidly, but shows them less clearly.

 See the *Advanced Guide* for the various playback methods available.

Erasing

1. In the playback mode, use the **←** or **→** button to select an image to erase (①) and press the **👉** button (②).

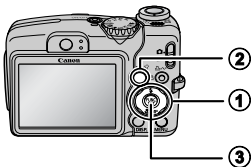

2. Confirm that [Erase] is selected and press the **FUNC./SET** button (③).
To exit instead of erasing, select [Cancel].



**Please note that erased images cannot be recovered.
Exercise adequate caution before erasing an image.**

➔ See the *Advanced Guide: Erasing All Images* (p. 82).

Menus and Settings

Settings for the shooting, playback or print modes or such camera settings as the date/time and sounds are set using the FUNC., Rec., Play, Print, Set up or My Camera menu.

FUNC. Menu

This menu sets many of the common shooting functions.

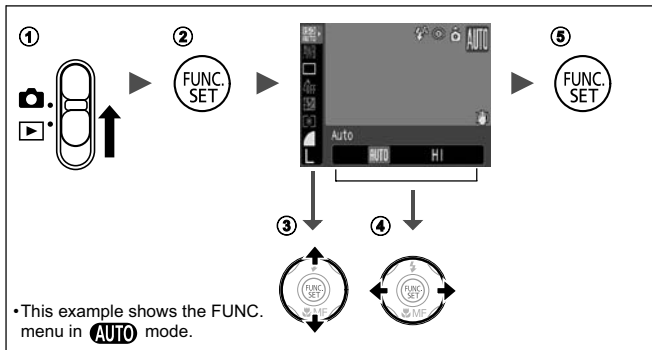

- 1 **Set the mode switch to (shooting).**
- 2 **Press the FUNC./SET button.**
- 3 **Use the or button to select a menu item.**
 - Some items may not be selectable in some shooting modes.
- 4 **Use the or button to select an option for the menu item.**
 - You can select further options with the **MENU** button for some options.
 - After selecting an option, you can press the shutter button to shoot immediately. After shooting, this menu will appear again, allowing you to adjust the settings easily.
- 5 **Press the FUNC./SET button.**

See the *Advanced Guide: Menu List* (p. 20).

Rec., Play, Print, Set up and My Camera Menus

Convenient settings for shooting, playback or printing can be set with these menus.

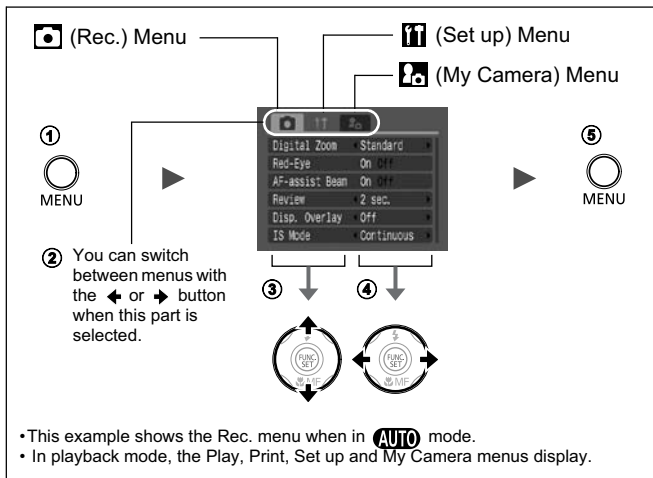

- ① Press the **MENU** button.
- ② Use the \leftarrow or \rightarrow button to switch between menus.
 - You can also use the zoom lever to switch between menus.
- ③ Use the \uparrow or \downarrow button to select a menu item.
 - Some items may not be selectable in some shooting modes.
- ④ Use the \leftarrow or \rightarrow button to select an option.
 - Menu items followed by an ellipsis (...) can only be set after pressing the **FUNC./SET** button to display the next menu. Press the **FUNC./SET** button again to confirm the setting.
- ⑤ Press the **MENU** button.

See the *Advanced Guide: Menu List* (p. 20).

Printing

Connect the camera to a direct print compatible printer*1 with a cable and simply press the  button on the camera.

1. Connect the camera to a direct print compatible printer and turn on the printer's power.

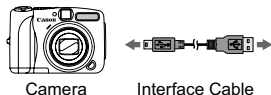

Canon Brand Printers



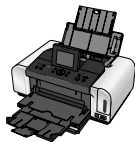

SELPHY CP Series
Compact Photo
Printers*2









PIXMA Series/
SELPHY DS
Series Bubble Jet
Printers

*1 Since this camera uses a standard protocol (PictBridge), you can use it with other PictBridge-compliant printers in addition to Canon-brand printers.

*2 You can also use card photo printers such as the CP-10/CP-100/CP-200/CP-300.

2. Turn on the power in playback mode and confirm that ,  or  is displayed in the upper left of the LCD monitor (1).

- The  button will light blue.
- The displayed icon will vary according to the printer model.
-   will display for movies.

3. Select an image to print using the  or  button (2) and press the  button (3).

The  button will blink blue and printing will start.

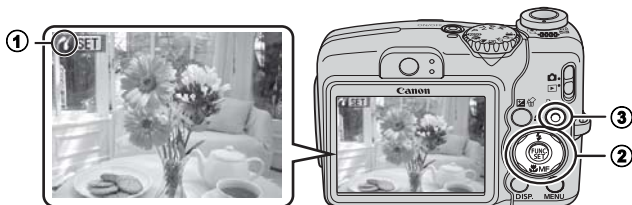

- ➔ See the *Advanced Guide: Setting the DPOF Print Settings* (p. 83).
- ➔ See the *Direct Print User Guide*.
- ➔ See the user guide for your printer.

Downloading Images to a Computer

The following methods can be used to download images recorded by the camera to a computer. Some methods, depending on the OS used, may not be available. Please read *System Requirements* (p. 25) in advance.

■ Camera to Computer Connection

Supplied Software	Install It		Do Not Install It
	Computer Procedure	Camera Procedure	Computer Procedure
OS Windows 98 Second Edition (SE)	●	●	—
Windows Me	●	●	—
Windows 2000	●	●	—
Windows XP	●	●	●
Mac OS X	●	●	●

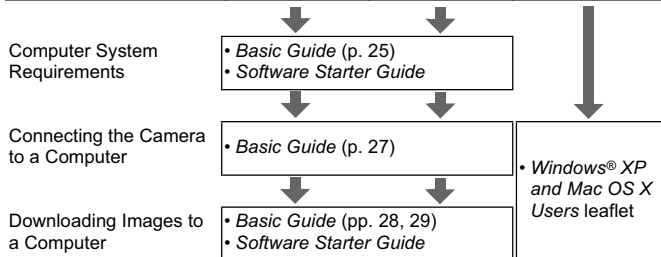

■ Using a Memory Card Reader

A memory card reader can be used with all the operating systems listed above. See the *Software Starter Guide* for details.

System Requirements

Please install the software on a computer meeting the following minimum requirements.

■ Windows

OS	Windows 98 Second Edition (SE) Windows Me Windows 2000 Service Pack 4 Windows XP (including Service Pack 1 and Service Pack 2)
Computer Model	The above OS should be pre-installed on computers with built-in USB ports.
CPU	Pentium 500 MHz or higher processor
RAM	Windows 98 SE/Windows Me 128 MB or more Windows 2000/Windows XP 256 MB or more
Interface	USB
Free Hard Disk Space	<ul style="list-style-type: none">• Canon Utilities<ul style="list-style-type: none">- ZoomBrowser EX 200 MB or more- PhotoStitch 40 MB or more• Canon Camera TWAIN Driver 25 MB or more• Canon Camera WIA Driver 25 MB or more
Display	1,024 x 768 pixels/High Color (16 bit) or better

■ Macintosh

OS	Mac OS X (v10.2 – v10.4)
Computer Model	The above OS should be pre-installed on computers with built-in USB ports.
CPU	PowerPC G3/G4/G5 or Intel processor*
RAM	256 MB or more
Interface	USB
Free Hard Disk Space	<ul style="list-style-type: none">• Canon Utilities<ul style="list-style-type: none">- ImageBrowser 200 MB or more- PhotoStitch 40 MB or more
Display	1,024 x 768 pixels/32,000 Colors or better

* EOS Utility (software for EOS DIGITAL series cameras) is only supported by PowerPC.

Preparing to Download Images

Ensure that you install the software first before connecting the camera to the computer.

■ Items to Prepare

- Camera and computer
- Canon Digital Camera Solution Disk supplied with the camera
- Interface cable supplied with the camera

1. Install the software.

1. Place the Canon Digital Camera Solution Disk in the computer's CD-ROM drive.

Macintosh Double-click the [Canon Digital Camera Installer] icon  in the CD-ROM window. When the installer panel appears, click [Install].



2. Click [Easy Installation].

Macintosh Select [Easy Installation] and click [Next].

Proceed with the installation while reviewing installation settings.



3. When the installation is complete, Click either the [Finish] or [Restart] button that appears.

Macintosh When the installation is finished, click [Exit].



4. Remove the Canon Digital Camera Solution Disk from the CD-ROM drive when your normal desktop screen appears.

2. Connecting the camera to a computer.

1. Use the supplied interface cable to connect the computer's USB port to the camera's DIGITAL terminal.

Slip your fingernail under the right edge of the camera's terminal cover, lift it open and plug the interface cable in all the way.

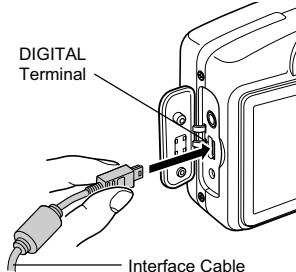
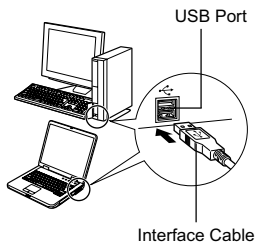

2. Set the camera's mode switch to  (playback) and turn on the power.

The camera and computer will be able to communicate.

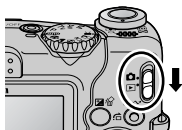

Always grasp the sides of the connector when disconnecting the interface cable from the camera's DIGITAL terminal.

Windows

If the Digital Signature Not Found window appears, click [Yes]. The USB driver will automatically finish installing onto the computer when you attach the camera and open a connection.

A window allowing you to set the preferences will appear when a connection is established between the camera and computer.

1. Select [Canon CameraWindow] and click [OK] (first time only).



If the window to the right does not appear, click the [Start] menu and select [All Programs] or [Programs], followed by [Canon Utilities], [CameraWindow], [PowerShot - IXY - IXUS - DV 6] and [CameraWindow].

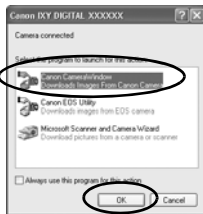

2. Download the images.

- Download the images using the camera or the computer.
- By default, the downloaded images are saved into the [My Pictures] folder.

Downloading Images Using the Camera (p. 30).

Downloading Images Using a Computer.
By default, all images that have yet to be downloaded will download.

You can set the type of image to download and the destination folder.



Thumbnails (small versions) of the downloaded images will display in the ZoomBrowser EX Main Window. By default, the downloaded images are saved into subfolders according to their shooting dates.



The following window will appear when you establish a connection between the camera and computer. If it fails to appear, click the [Canon CameraWindow] icon on the Dock (the bar which appears at the bottom of the desktop).

1. Download the images.

- Download the images using the camera or the computer.
- By default, the downloaded images are saved into the [Pictures] folder.

Downloading Images Using the Camera (p. 30).

Downloading Images Using a Computer. By default, all images that have yet to be downloaded will download.





You can set the type of image to download and the destination folder.

Thumbnails (small versions) of the downloaded images will display in the ImageBrowser Browser Window. By default, the downloaded images are saved into folders according to their shooting dates.



Downloading Images Using the Camera (Direct Transfer)

Use this method to download images using camera operations. Install the supplied software and adjust the computer settings before using this method for the first time (p. 26).

	All Images	Transfers and saves all images to the computer.
	New Images	Transfers and saves to the computer only the images that have not been previously transferred.
	DPOF Trans. Images	Transfers and saves to the computer only the images with DPOF Transfer settings (<i>Advanced Guide</i> p. 86).
	Select & Transfer	Transfers and saves single images to the computer as you view and select them.
	Wallpaper	Transfers and saves single images to the computer as you view and select them. The transferred images display on the computer desktop.

1. Confirm that the Direct Transfer menu is displayed on the camera's LCD monitor.

- The  button will light blue.
- Press the **MENU** button if the Direct Transfer menu fails to appear.

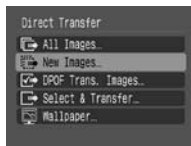

Direct Transfer Menu





■ All Images/New Images/DPOF Trans. Images

2. Select , or and press the button.

- The images will download. The  button will blink blue while downloading is in progress. The display will return to the Direct Transfer menu when the download is complete.
- To cancel the download, press the **FUNC./SET** button.



■ Select & Transfer/Wallpaper

2. Select  or , and press the  button (or the FUNC./SET button).
3. Select images to download and press the  button (or the FUNC./SET button).

- The images will download. The  button will blink blue while downloading is in progress.
- Images can also be selected during index playback (*Advanced Guide* p. 71).
- Press the **MENU** button to return to the Direct Transfer menu.



Only JPEG images can be downloaded as wallpaper for a computer. On the Windows platform, the files are automatically created as BMP images.



The option selected with the  button is retained even when the camera's power is turned off. The previous setting will be in effect the next time the Direct Transfer menu is displayed. The image selection screen will appear directly when the [Select & Transfer] or the [Wallpaper] option was last selected.

Safety Precautions

Be sure to read, understand and follow the safety precautions below when using the camera, in order to prevent injury, burns or electrical shock to yourself and others.

Be sure to also read the safety precautions listed in the *Advanced Camera User Guide*.

Warnings

- Do not trigger the flash in close proximity to human or animal eyes.
- Store this equipment out of the reach of children and infants.
- Avoid dropping or subjecting the camera to severe impacts. Do not touch the flash portion of the camera if it has been damaged.
- Stop operating the equipment immediately if it emits smoke or noxious fumes.
- Do not handle the power cord if your hands are wet.
- Do not use batteries which are not specified for this camera.
- The compact power adapter output terminals have been designed exclusively for this equipment. Do not use them for other products.